

Name: \_\_\_\_\_

# Perimeter of a Polygon

Find the perimeter of each shape by adding the lengths of each side.

a.

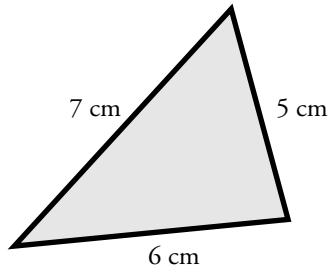

b.

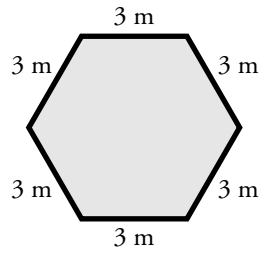

c.

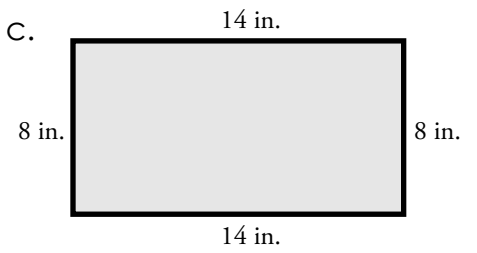

d.

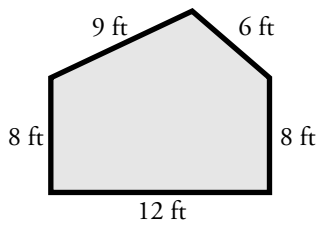

e.

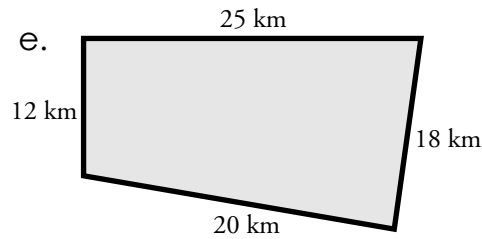

f.

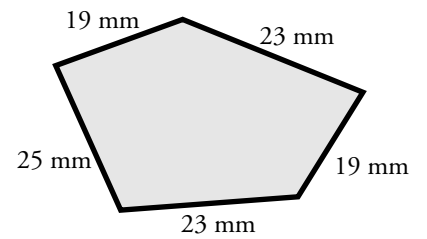

g.

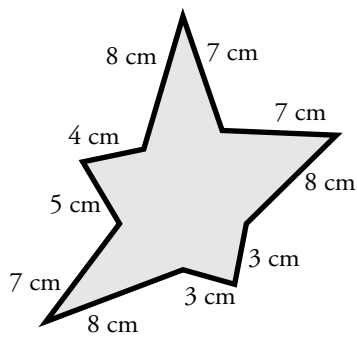

h.

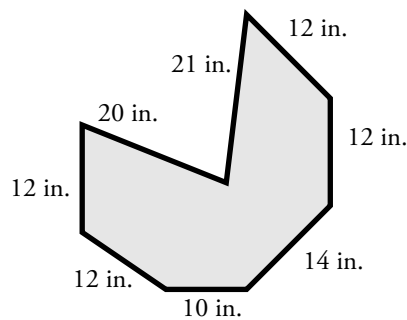

i.

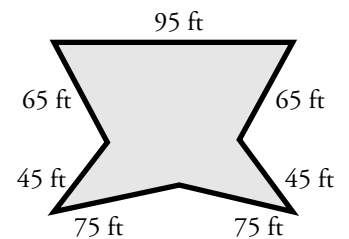

**Challenge:** Draw a square with a perimeter of 180 yards.  
Label the lengths of each side.

# ANSWER KEY

## Perimeter of a Polygon

Find the perimeter of each shape by adding the lengths of each side.

a.

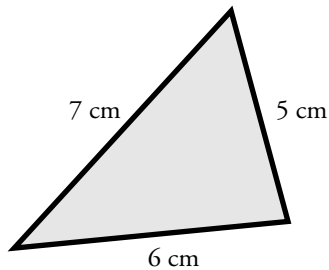

**18 cm**

b.

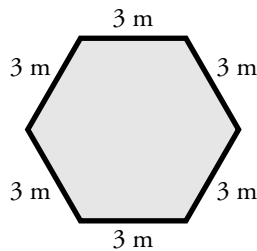

**18 m**

c.

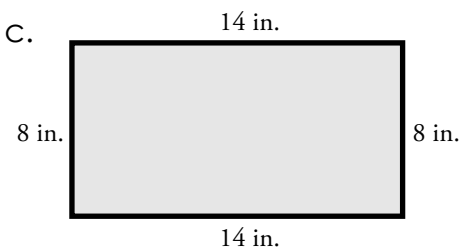

**44 in.**

d.

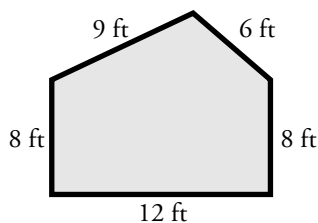

**43 ft**

e.

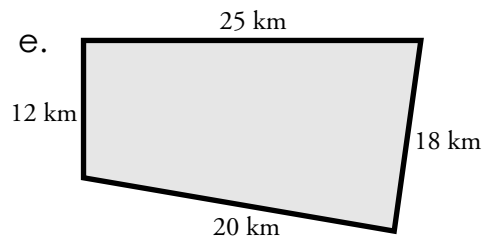

**75 km**

f.

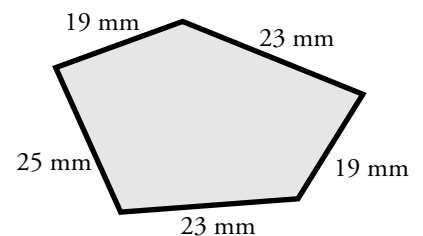

**109 mm**

g.

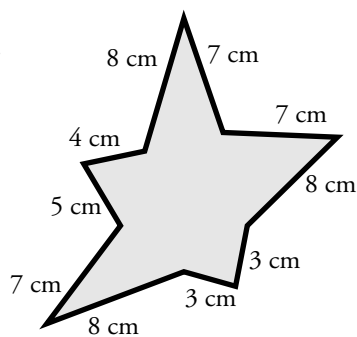

**60 cm**

h.

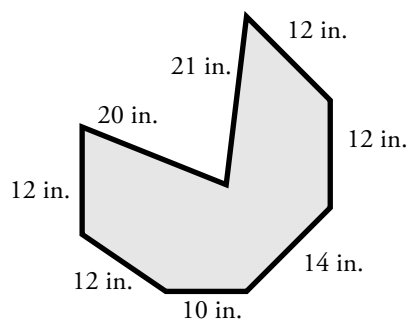

**113 in.**

i.

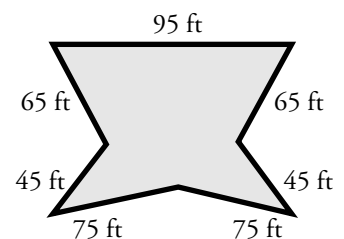

**465 ft.**

**Challenge:** Draw a square with a perimeter of 180 yards. Label the lengths of each side.

